

PROLEĆNI BILTEN

2010



- presovani program

- liveni program

- parkovski program

- bazenski program

- roštilji



preko 600m
pločnika dnevno,
preko 1000 komada
livičnjaka na dan
I još mnogo oblika
raznih boja I načina
obrade (brušeno, štokovano...)



O NAMA

Preduzeće **"DEKRA-S"**, Ledinci je malo porodično preduzeće koje je osnovano 1991. godine. U početku preduzeće se bavilo izvođenjem građevinskih radova, a posle par godina, proširilo je svoju delatnost proizvodnjom betonske galanterije i veleprodajom opreme za građevinarstvo.

Osnivač i direktor preduzeća je Siniša Obradović, građ.ing. a preduzeće je organizovano kao jednočlano društvo sa ograničenom odgovornošću.

Iza nas stoji petnaestogodišnje iskustvo u proizvodnji proizvoda od betona i spadamo u značajnije proizvođače u ovoj oblasti.

Prednosti naše proizvodnje su visok kvalitet proizvoda i brza prilagodljivost specifičnim zahtevima tržišta.

Dobitnici smo mnogih priznanja, medalja, pehara sa sajmova građevinarstva u zemlji i inostranstvu, kako za širok asortiman proizvoda, tako i za izuzetan kvalitet.

Naši najveći kupci su Direkcije za puteve i JKP za puteve širom Srbije, građevinska preduzeća koja se bave ugradnjom naših proizvoda, kao i veliki broj privatnih lica, koja su svoje domove uredili sa našim proizvodima.

Naša tržišna pozicija je da smo lider u asortimanu proizvoda i među 10 najvećih proizvođača betonske galanterije u regionu.

UPUTSTVO ZA POSTAVLJANJE PLOČNIKA



Iskop mora biti 30-50 cm širi od predviđene površine koja se želi popločati. Nosivi sloj za ugradnju pločnika treba biti debljine 20-35 cm, a sastoji se od prirodnog ili drobljenog šljunka fi 0-32mm, koji se ugrađuje po slojevima sa odgovarajućom mehanizacijom. Zbijanje materijala se vrši vibracijskim valjkom do projektiranog modula zbijenosti. Radi odvodnje, nosivi sloj mora imati nagib u tačnosti od 1 cm. Površina nosivog, dobro zbijenog sloja uvek je niža od gotove površine popločavanja plus 2-4 cm. Kod rigola, slivnika, poklopaca i dr. priključaka prema drugim građevinama moraju se predvideti vremenska sleganja gotove površine. Gotove površine su pre vibriranja 2-5 mm iznad rubova takvih gotovih elemenata. Kada se površina dobro pripremi, na dobro zbijenu površinu nanosi se sloj drobljenog peska, granular 4-8 mm. Pesak ili tucanik se razvlače aluminijumskom letvom ravnomerno po površini. Takvom površinom se ne sme hodati. Na nju se polažu elementi za popločavanje 2-8 cm debljine po kojima se sme hodati. Nakon postavljanja elemenata za popločavanje prilazimo čišćenju površine, koja se nabija ili ravna vibro pločom koja je ispod obložena gumenom površinom. Nakon toga se popločana površina ispunjava isključivo suvim peskom. Postupak treba ponoviti više puta da popločana površina dobije lep i prirodan izgled. Najnovija iskustva pokazuju da fugne ne treba zapunjavati. Eventualne razlike u nijansi boja kod pojedinih elemenata za popločavanje tehnički su uslovljene tj. elementi su proizvedeni u različitim vremenskim razmacima, pri različitim temperaturama, pri različitoj vlažnosti, a mogu biti i u boji cementa isl. Prema iskustvu, razlike u boji tokom vremena nestaju i sve se ujednačava usled korišćenja i vremenskih uticaja. Razlike u nijansama boja kod elemenata od sivog cementa, takodje mogu nastati zbog samog cementa jer proizvođači ove sirovine ne mogu da garantuju boju cementa. Kod betonskih elemenata moguća je pojava tzv "cvetanja" betona, naročito u zimsko-prolećnom periodu, koja vremenom nestaje i ne smatra se nekvalitetom. Ovu pojavu je moguće ublažiti dodavanjem aditiva u sam beton, kao i posebnom negom betona, što je potrebno naglasiti prilikom samog ugovaranja.

Za svaku porudžbinu proizvoda, potrebno je pojedinačno ugovaranje. Proizvođač zadržava pravo izmene cenovnika, isti je orijentacioni. Izveštaji o kvalitetu proizvoda se rade na zahtev kupca, a kontrola kvaliteta je konstantna.



"DEKRA-S" d.o.o.
 Fruškogorska 47
 21207 Ledinci
 Republika Srbija

PROIZVODNJA
 BETONSKE GALANTERIJE
 I
 TRGOVINA
 GRADEVINSKOM OPREMOM



Telefon: +381 21 464 174
 Fax: +381 21 462 255
 Mobilni: +381 62 6000 64

NAZNAČENE MARKICE O KVALITETU PROIZVODA OMOGUĆAVAJU KUPCU DA SAM IZABERE KVALITET PROIZVODA

- | | | | |
|---|--|---|---|
|  | GARANCIJA |  | BRUŠENI ELEMENTI |
|  | ČVRSTOĆA |  | PESKARENI ELEMENTI |
|  | UPIJANJE VODE |  | ŠTOKOVANI ELEMENTI |
|  | MRAZ - SO |  | PRANI ELEMENTI |
|  | ELEMENTI OD SIVOG CEMENTA |  | RUSTIK ELEMENTI (rustik rubovi) |
|  | ELEMENTI OD BELOG CEMENTA |  | ELEMENTI SA SMANJENIM
PRIJANJANJEM ŽVAKAČIH GUMA |
|  | PRESOVANI ELEMENTI (jednoslojni/dvoslojni) |  | ELEMENTI SA ZAŠTITNIM
PREMAZIMA |
|  | LIVENI ELEMENTI (jednoslojni/dvoslojni) |  | B-G ELEMENTI (BETON-GUMA)
d=2.5-8cm |
|  | ELEMENTI SA KVARCOM |  | PROTIVKLIZNI |
|  | ELEMENTI SA GRANITOM |  | OTPORNO NA NAFTNE DERIVATE |
|  | ELEMENTI SA MERMEROM |  | JEDNAKE POVRŠINE |

• TON KARTA

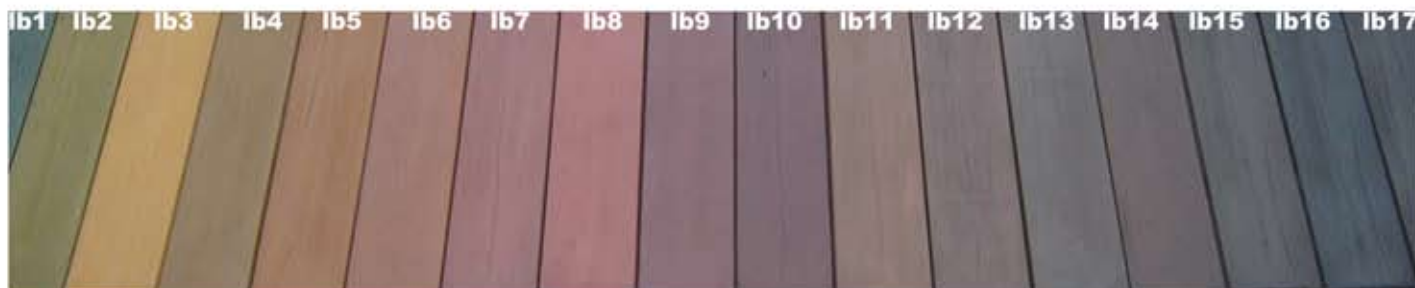

Ukoliko kupac nije stručan, potrebno je kontaktirati dobavljača



211123p



BEHATON



16,4/20,6-8cm
POTROSNJA-35 kom/m²

OLIMPIJA

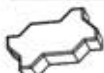

16,5/24,5/6cm
POTROSNJA-40 kom/m²

REKET



22/13/6cm
POTROSNJA-38 kom/m²

CVET



24/13/6cm
POTROSNJA-40 kom/m²

LEPEZA



21,5/16/6-8cm
POTROSNJA-41 kom/m²

BAROK+



22/26/6-8cm
POTROSNJA-28 kom/m²

MEBA



60/40/10cm
POTROSNJA-4kom/m²

RUSTIK



28/21/6
21/14/6
14/14/6
7/14/6

CIGLA



10,5/21cm
POTROSNJA-45 kom/m²

SACE



MALO-18,5/16cm
POTROSNJA-44 kom/m²

SACE



VELIKO-23,5/20,5cm
POTROSNJA-26 kom/m²

VENECIJA



20/20/6-8cm
POTROSNJA-25 kom/m²

TRAPEZ



34/15/6-8cm
POTROSNJA-26 kom/m²

PLOČE



40/40/6-8cm
30/30/6-8cm
32/32/6-8cm
30/30/6-8cm
10/10/6-8cm



40/20/6-8cm
30/20/6-8cm
30/15/6-8cm



40/40/6-8cm
25/12/6-8cm

PLOČE ZA SLEPE



40/40/6-8cm
30/30/6-8cm

KORUBA



51/48/20cm
40/40/18cm
20/30/8cm

KANALETE

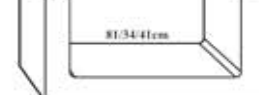
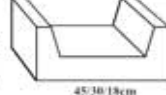

45/30/18cm
50/40/30cm
81/34/11cm

LEŽEĆI



30/30/40
30/20/28
30/30/40/10
20/30/18/6

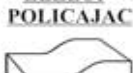

30/30/12cm

BLOK ZA UREĐENJE OBALA



20/40cm

BETONSKI ELEMENTI ZA ŽARDINJERE



40/40/48/30/8cm
40/20/30/8cm



40/50/30/8cm



15/50/30/8cm



80/40/30/8cm

DIMNJAČKA KAPA I VRAT



56,5/45/20cm

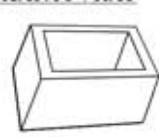

50/41/20cm

DIMNJAČKI VENTILACIONI BLOKOVI



30/30/25cm

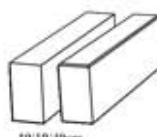

40/19/40cm



7/20/49cm



18/12/30/60/80cm



20/24/60cm

IVIČNJACI



18/12/30/60/80cm



20/24/60cm

BEHATON



PRESOVANI PROGRAM

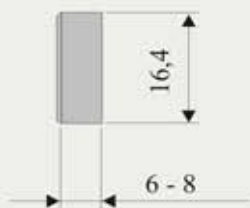

Potrošnja

35 kom/m²

OLIMPIJA

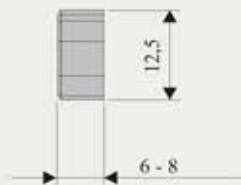
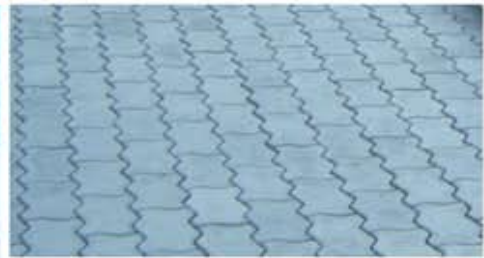

Potrošnja

40 kom/m²

PRESOVANI PROGRAM

REKET

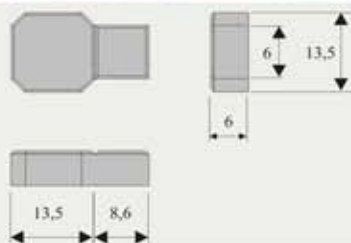

Potrošnja

38 kom/m²

CVET

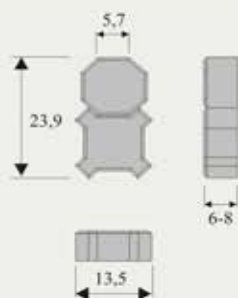

Potrošnja

40 kom/m²



LEPEZA

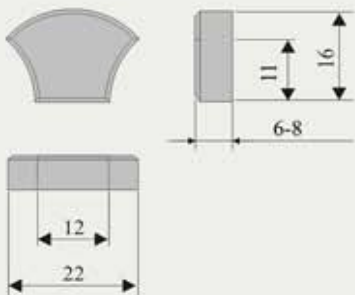

Potrošnja

41 kom/m²

PRESOVANI PROGRAM

MEBA RASTER



PRESOVANI PROGRAM

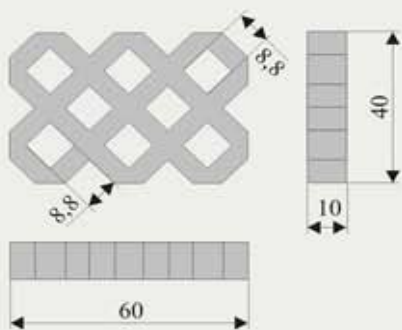

Potrošnja

4 kom/m²



PLOČE

10x10, 10x20, 20x20
20x30, 30x30

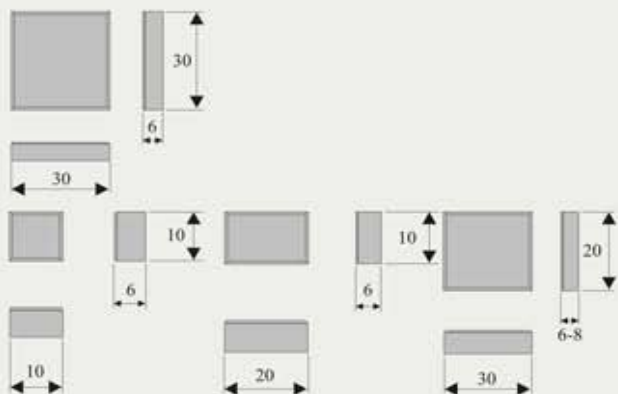

Potrošnja

10x10 - 100 kom/m²

10x20 - 50 kom/m²

20x20 - 25 kom/m²

20x30 - 16.5 kom/m²

30x30 - 11 kom/m²

PRESOVANI PROGRAM

RUSTIK



PRESOVANI PROGRAM



Dimenzije

28/21/6 cm

21/14/6 cm

14/14/6 cm

7/14/6 cm



PETROVARADIN

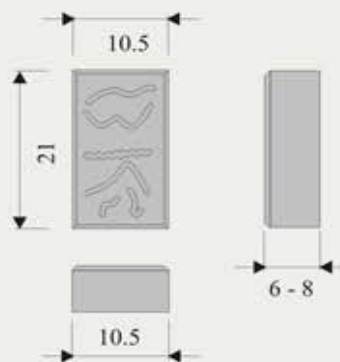

PRESOVANI PROGRAM

KANALETE

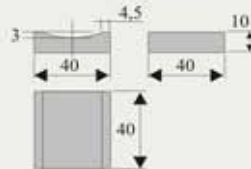
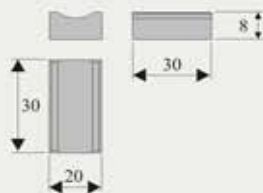
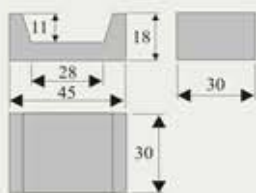

Potrošnja

45/18/30 - 3,3 kom/m'

40/40/10 - 2,5 kom/m'

30/20/8 - 3,3 kom/m'

PRESOVANI PROGRAM



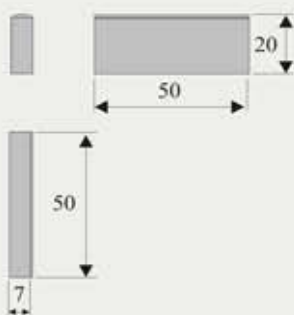
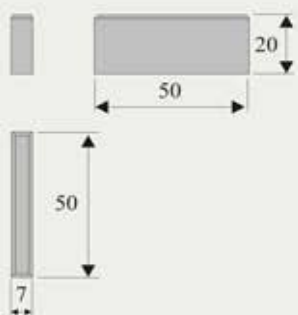













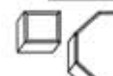















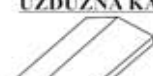
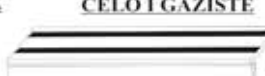









IVIČNJACI



Potrošnja

2 kom/m¹



<p>BEHATON</p>  <p>16,4/20/6-8cm POTROŠNJA-35 kom/m²</p>	<p>HRAPAVA KOST</p>  <p>22/13,5/2,5-4-4cm</p>	<p>SACE</p>  <p>18,5/16/2,5-4-6cm POTROŠNJA-42 kom/m²</p>	<p>SACE III-a</p>  <p>18/18/2,5-4-4cm</p>	<p>LEPEZA</p>  <p>24/17 d=4-2,5 cm POTROŠNJA-32 kom/m²</p>	<p>BAROK</p>  <p>22/26/6-8cm POTROŠNJA-28 kom/m²</p>	<p>MOZAIK</p>  <p>d=6/4-2,5 cm POTROŠNJA-33 kom/m²</p>	<p>RASTER</p>  <p>26/26 d=6/4-2,5 cm POTROŠNJA-14,5 kom/m²</p>
<p>HRAPAVA CIGLA</p>  <p>10,5/21cm POTROŠNJA-32 kom/m²</p>	<p>KANALETE</p>  <p>25/35/8</p>	<p>PLOČA</p>  <p>16/25/6</p>	<p>KRUG NIŠ</p> 	<p>DASKA</p>  <p>43/14/2,5</p>	<p>LIVENA REŠETKA</p>  <p>armatura-06 ili ø10 45/39/6</p>	<p>SVEDSKI SLOG</p>  <p>36/36/5</p>	<p>OKAPNICA ZA STUBOVE</p>  <p>POTROŠNJA-5 kom/m²</p>
<p>BUNJA</p>  <p>25/25 d=2,5 cm POTROŠNJA-16 kom/m²</p>	<p>PLOČA</p>  <p>25/25 d=6 cm POTROŠNJA-16 kom/m²</p>	<p>PLOČA</p>  <p>30/30 d=4,5 cm POTROŠNJA-11 kom/m²</p>	<p>PLOČA</p>  <p>30/30 d=4,5 cm POTROŠNJA-11 kom/m²</p>	<p>ČELO</p> 	<p>BAZENSKA OBLOGA</p>  <p>40/40 h=5cm</p>		
<p>UZDUŽNA KAPA</p>  <p>27/39/3</p>	<p>ČELO I GAZIŠTE</p>  <p>GAZIŠTE-125/33/5 ČELO-125/15/3</p>	<p>GAZIŠTE</p>  <p>35/27/2cm</p>	<p>GAZIŠTE</p>  <p>30/25/3cm</p>	<p>ČELO</p>  <p>25/17/3cm</p>	<p>ČELO</p>  <p>35/17/3cm</p>		
<p>IVIČNJACI</p>  <p>12/18/6cm 12/18/30cm</p>	<p>IVIČNJACI</p>  <p>18/24/6cm 18/24/30cm</p>	<p>IVIČNJACI</p>  <p>20/24/6cm 20/24/30cm</p>	<p>IVIČNJACI</p>  <p>5/13/50cm</p>	<p>IVIČNJACI</p>  <p>8/16/50cm</p>	<p>IVIČNJACI</p>  <p>8/16/25cm</p>	<p>IVIČNJACI</p>  <p>10/8/40cm</p>	<p>UGAONI IGAZONSKI IVIČNJACI</p> 
<p>IVIČNJACI</p>  <p>7/21/50cm</p>	<p>IVIČNJACI</p>  <p>10/25/50cm</p>	<p>IVIČNJACI</p>  <p>8/21/50cm</p>	<p>IVIČNJACI</p>  <p>18/36/50cm</p>	<p>IVIČNJACI</p>  <p>15/28/50cm</p>	<p>RADIJALNI IVIČNJACI</p>  <p>10/12/35cm 10/12/40cm</p>	<p>ARMIRANI POKLOPAC</p>  <p>50/50/10cm</p>	

SAĆE III



LIVENI PROGRAM

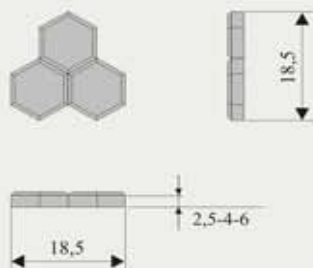

Potrošnja

44 kom/m²



SAĆE I



18,5/16/2,5-4-6 cm



Potrošnja

42 kom/m²



BAROK

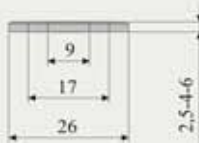

Potrošnja

28 kom/m²

LIVENI PROGRAM

BAZENSKI ELEMENTI



LIVENI PROGRAM

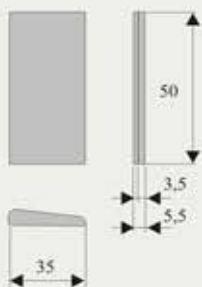
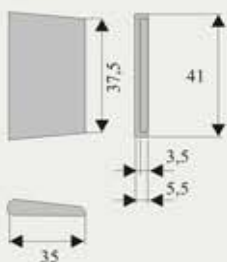

Potrošnja

konus - 0.4 kom/m'

ravni - 0.5 kom/m'



PLOČA 50x50

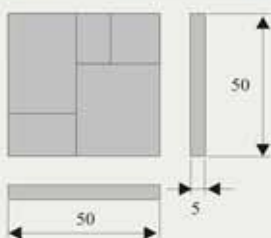

Potrošnja

4 kom/m²



PLOČA SUZA

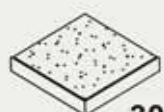

30/30/4,5 cm



Potrošnja

11 kom/m²

LIVENI PROGRAM

LIVENI IVIČNJACI



LIVENI PROGRAM



12/18



18/24



20/24



5/13



8/16



KANALETE

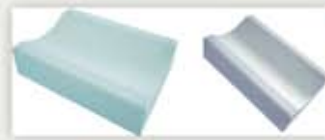
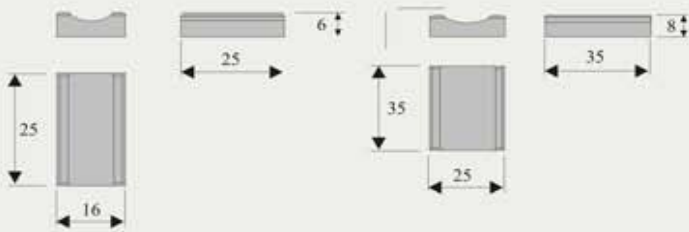

Potrošnja

25/16/6 - 4 kom/m¹

35/25/8 - 3 kom/m¹



PARKING KUGLA SA VRATOM

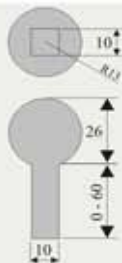

OGRADE



LIVENI PROGRAM

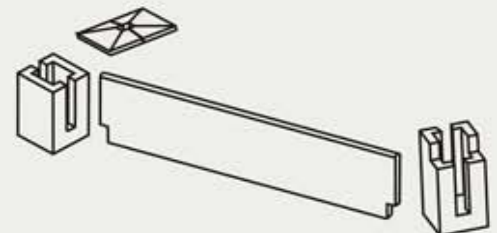
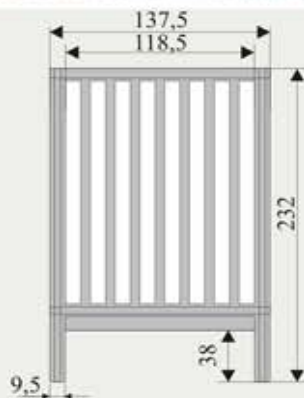



PARKOVSKI PROGRAM

PARKOVSKI PROGRAM



KLUPA SA NASLONOM



KORPA ZA SMEĆE



BETONSKA KORPA ZA SMEĆE



STALAK ZA SUNCOBAN



ZARDINJERA



KLUPA BEZ NASLONA



GAŠER SLAVNIK



ZASTIENI STUBIĆI



Dvostrana



Trudolna
KEGLE ZA
PARKIRALIŠTA
(koleg i glatki)



ČESMA



PLAŠT DIMNJAKA DENEZA

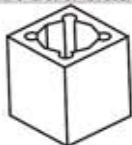

DIMNJAČKI VENTILACIONI BLOKOVI

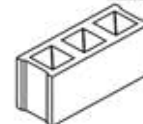
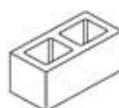
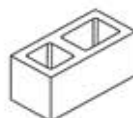

BETONSKI BLOK

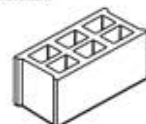



SANUČASTA



SA NOGICAMA

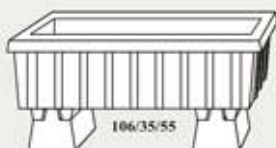

KONUSNA

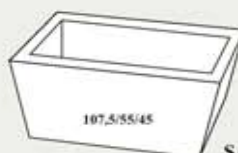

PEHARASTA



KUPASTA



OKRUGLA



SANUČASTA





POTPORNE ŽARDINJERE

PARKOVSKI PROGRAM



ŽARDINJERA
ZA POTPORNI ZID



30/30/13



TRODELNA KUGLA ZA PARKING OD PRANOG KULIRA

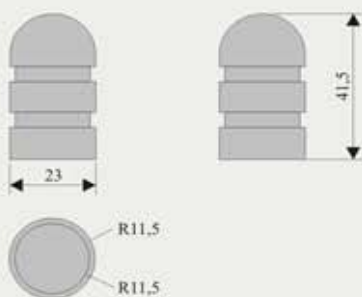

PARKOVSKI PROGRAM

ZAŠTITNI STUBIĆI

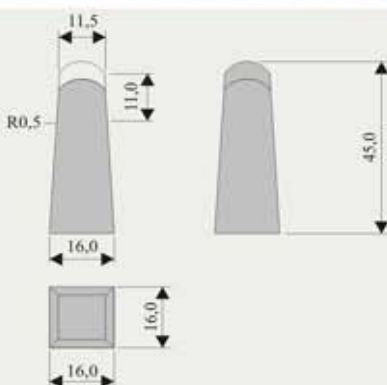



ROŠTILJI



ERA 200



ERA 130



ERA 90



PERA 60



PERA 50



PEČNICA

ROŠTILJI

magazin za ugostiteljstvo i turizam

caffe

Vojvodina



SVAKO VEČE ŽIVA SVIRKA

**BROD RESTORAN
LAHOR**



BEOGRAD, BUL.VOJVODE MIŠIČA 14, SAJAMSKI KEJ

TEL.011/361-4499

АКВАТЕРМ

ПРОЈЕКТОВАЊЕ И ИЗВОЂЕЊЕ ЗАЛИВНИХ СИСТЕМА, БАЗЕНА
ИНСТАЛАЦИЈЕ И ОПРЕМА ВОДОВОДА, ГРЕЈАЊА-ГАСА

- фонтане
- заливни системи
- базени
- кућне инсталације
- водовода и грејања
- гасне инсталације



Каћ, Добровољачка 58

Tel: 021/6212-151 Tel/ Faks: 021/6337-177 021/6337-107

e-mail: akvaterm@nscable.net akvaterm@neobee.net

Жиро рачун: 355-1043122-79 PIB: 102736206



Iskren prijatelj prirodi i čoveku

EKOlist



magazin iz oblasti ekologije, zaštite životne sredine, održivog razvoja, zdravih stilova života

kontakt:

mob: 0658880857

tel/fax: 021/ 782-244

ekolist@yahoo.com

www.ekolist.org



**UGRADNJA SVIH VRSTA INDUSTRIJSKIH PODOVA
GARANCIJA 5 GODINA**

INSTRUKTOR⁰²¹
Industry Flooring
... PODOVI NA KOJE SE MOŽETE OSLOINITI !



Vaš pod je vaša slika

"Instruktor 021" doo, Petra Kočića 8, Đurđevo, Novi Sad
www.instruktor021.com, office@instruktordoo.com

PJ. Radomira Raše Radujkova 12, Novi Sad; Tel/fax: 021 49 40 02, 021 49 33 29

WWW.MAXBET.RS

Slot  Club

MAXBET

PRONAĐITE SREĆU! DOBRO DOŠLI!

U NOVOM SADU:

★ Braće Ribnikar 8

★ Jevrejska 35

★ Fruškogorska 20

★ Sentandrejski put BB

★ Bul. Oslobođenja 27

★ Bul. Oslobođenja 46

★ Bul. Oslobođenja 65

★ Sutjeska 2

★ Temerinska 34



Slot Club

Sportska Kladionica



контакт информације

СПАГОС д.о.о. Београд

тел: 011/3171 350

моб: 063/ 373 544 и 064/ 64 567 26

www.spagos.rs

spagosdoo@yahoo.com ; office@spagos.rs



Компанија СПАГОС д.о.о. Београд се бави испоруком и монтажом брвнара, дрвених облога за спољну и унутрашњу уградњу (паркет, бродски под, декинг, дрвене фасаде, шиндра и др.).

Брвнаре СПАГОС су ручне израде, од пуних трупаца смреке, пречника 20-40 цм. У могућности сте да изаберете неки од наших модела, или да сами креирате сопствени модел. Величину брвнаре, избор и распоред просторија одређујете сами.

Дрво је природан и еколошки потпуно чист материјал и као такав представља најздравију животну средину. Дobar је изолатор, лети нас штити од несносних врућина, а зими помаже брзом и лаким загревању простора. Веома је издржљиво у разним временским условима и траје по неколико стотина година.

Брвнаре “СПАГОС” - да поживите дуго и будете здрави



TRGOVINA, OPREMA, RENTIRANJE,
ODRŽAVANJE, PROIZVODNJA
MAŠINA ZA OBRADU BETONA
IRIG, INDUSTRIJSKA ZONA BB
RUMSKI PUT
+381 64 820 84 04; +381 64 820 84 00
Fax: + 381 22 449 229
e-mail: doo.toro@gmail.com

Valjci, vibro ploče, vibro igle, vibro letve, vibro stolovi, vibro motori, helikopteri, mašine za rezanje betona, mešalice, kalupi za probne kocke, mehanički sečko, tamperi. Sva oprema za obradu betona i ugradnju prefabrikovanih betonskih elemenata za niskogradnju i visokogradnju. **PROMO CENE**-ograničena količina



Utovarivači (viljuškari) od 0,8t do 3,5t, mini utovarivači, damperi.
PROMO CENE utovarivača nosivosti 1,8t ograničene količine

Mobilni merni sistemi

Za.....



**Prenos podataka -
Obrada podataka.....**



Tel : 021-6433-742
Fax : 021-6433-589

Web : www.elmerpro.com
E-mail : djura@elmerpro.com



Prese za proizvodnju betonske galanterije, kao i kompletne linije. Projektovanje, trgovina i montaža kompletnih sistema. Izrada alata za sve tipove mašina...



Betonare od 0,5 do 4 m³, protivstrujne sa dve osovine. Moguća kupovina komponenti, polu-automatskih i automatskih. 30m³/h betona...

PROMO CENA

SEČENJE VODENIM MLAZOM WATER JET CUTTING



MLAZOM DO CILJA



Nudimo vam usluge sečenja:

- svih vrsta čelika: hladno valjani čelici, toplo valjani čelici, hardox, legurisane čelike...
- inox, bakar, aluminijum, aluminijumska saća, mesing, titanijum...
- sve vrste keramika (keramičke pločice, izrada intarzija, listela, mozaika, isecanje raznih motiva, oblika, u vidu slobodne forme u arhitekturi i građevinarstvu, kao i skraćivanje pločica na meru)
- granit, mermer, beton,
- staklo (ogledalo), plesiglas, plastika, klirit, teadit, drvo, iverica, lesonit, meki sunđer, karton,

Nova tehnologija koju želimo da vam predstavimo je rezanje **PUTEM VODENOG MLAZA CNC** mašinom **WATER JET**. Materijali koji se mogu seći jesu svi metali i nemetali koji trpe vodu. Ne postoje ograničenja u obliku, a maksimalna debljina materijala je 120mm. Radna površina Water Jet-a je 3000x1500mm.

Tehnologija abrazivnog sečenja vodenim mlazom kao vrhunski rezultat daje nepromenjenu strukturu materijala, a u zoni mlaza proces je potpuno hladan, tako da nema opasnih gasova kao nus produkta nekih drugih metoda.



Sa novom tehnologijom se postiže značajno **smanjenje troškova** proizvodnje kako serijske tako i izrade prototipa. Visoka preciznost i kvalitet reza u većini slučajeva ne zahteva završnu obradu (projektovana greška je max. 0.2mm)

Sr. Kamenica Sonje Marinković 2a
tel/fax: +381 21 464 174

Ruma-Kraljevci Rumski put bb
tel/fax: +381 22 449 229

web: www.aquarez.rs
e-mail: office@aquarez.rs
mob: + 381 62 6000 65

SEČENJE VODENIM MLAZOM WATER JET CUTTING

 e-mail: office@aquarez.rs
 web: www.aquarez.rs

Slobodna forma sečenja najistaknutija je kod keramike, odnosno tzv. intarzija. One su prosečene i kombinovane sa drugom vrstom pločica, drugom bojom ili pak nekim drugim materijalom kao npr. mermerom, granitom, inox-om ili bakrom... Kod ove tehnike potrebna je kreativnost, mašta i uz jednu olovku možete doći do realizacije projekta. Nakon toga, vas proekat morate pretočiti u elektronsku formu, AUTO CAD (*.dwg ili *.dxf).

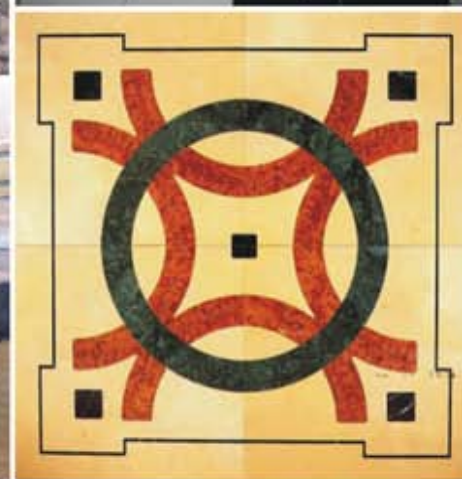

MI REALIZUJEMO SVE ŠTO

INTARZIJE-MOZAICI



**KOMBINOVANJE RAZNIH OBLIKA I MATERIJALA DO 100mm DEBLJINE
(KERAMIKA, GRANIT, MERMER, STAKLO, PLASTIKA, ROSFRAJ...)**

VI ZAMISLITE

ATELJE INTARZIJA
Giacomo Casanova 12, Vrsar
CRO +385 98 94 35 214
SRB +381 62 6000 64
ateljeintarzija@gmail.com



www.uredjenjestana.com

**Jedini srpski online magazin
o uređenju enterijera
Oglasite se na pravom mestu!**

BETON GUMA

EXCLUSIVE

POGON "B-G"

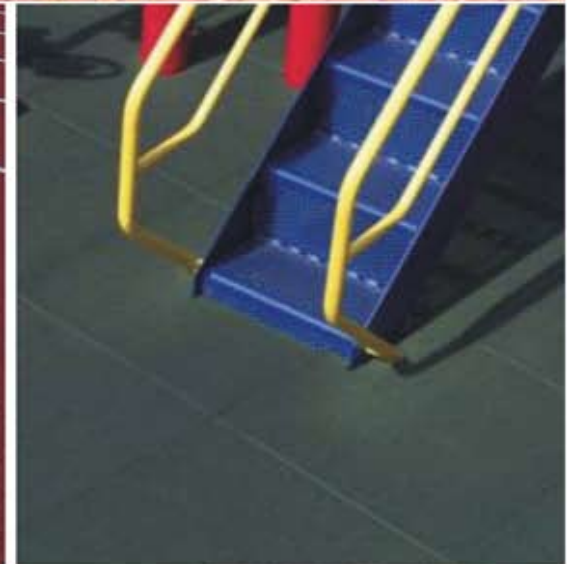

Pogon "B-G" proizvodi elemente u kombinaciji "beton-guma": **PLOČE** dim.50/50 d=4+3 cm, **IVICNJAKE** dim. 8x100/15+5 cm i **GAZIŠTA** za stepeništa, koji su namenjeni za objekte kao što su **dečija igrališta, vrtići, sportski tereni, bolnice, gerontološki centri...**

Prednosti beton-guma podnih obloga- elastične sa potrebnom čvrstoćom, nisu toksične, otporne na habanje, ne klize, vodootporne, dugovečne, smanjuju opasnost od povreda i ozleda pri padu...

LIVENA DASKA

NOVO

EXCLUSIVE

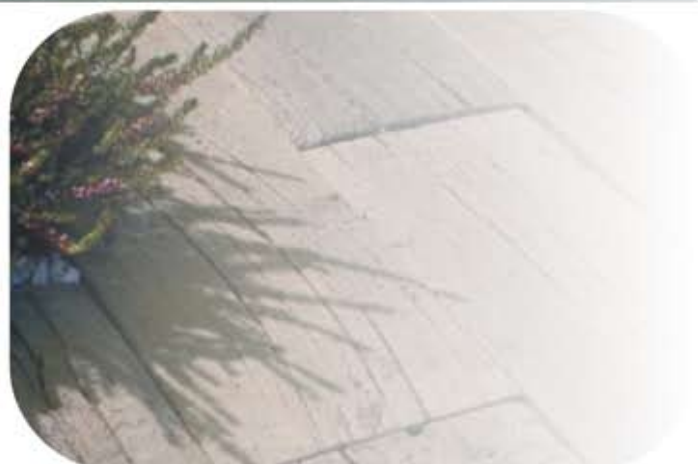

NOVO

EXCLUSIVE

KONTAKT



“DEKRA-S” d.o.o.
Fruškogorska 47
21207 Ledinci
Republika Srbija

**PROIZVODNJA
BETONSKE GALANTERIJE
I
TRGOVINA
GRAĐEVINSKOM OPREMOM**

Pogon I
NOVI SAD
(SREMSKA KAMENICA)
Sonje Marinković 2a
Telefon: +381 21 464 174
Fax: +381 21 462 255
Mobilni: +381 62 6000 64



Pogon II
BEOGRAD
(PEĆINCI)
Školska 53
Telefon: +381 22 85 324
Fax: +381 21 462 255
Mobilni: +381 62 6000 64



DONOSIOCI OVOG BILTENA IMA PRAVO NA POPUST
U ZAVISNOSTI OD TIPA I KOLIČINE NARUČENE ROBE
10% DO 40%

AKCIJA VAŽI DO 30.06.2010.

office@dekra-s.rs
www.dekra-s.rs

Mapa nije garancija u odnosu na stvarnost.
Navedeni nazivi su pojedinačne stavke za informaciju.
Sve informacije posrednik dostavlja.